

LIGHT ENGINE USER MANUAL

MODEL:

LEI - 4001/WP

LEI - 8001/WP

LEI - 15001/WP

LEI - 4001DMX/WP

LEI - 8001DMX/WP

LEI - 15001DMX/WP

LEJ - 4001DMX/WP

LEJ - 8001DMX/WP

Accessories:

- Fiber Connector1 PC
- Wireless Remote Controller.....1 PC (Optional)
- User Manual1 PC
- Signal Cable1 PC (for DMX machine only)

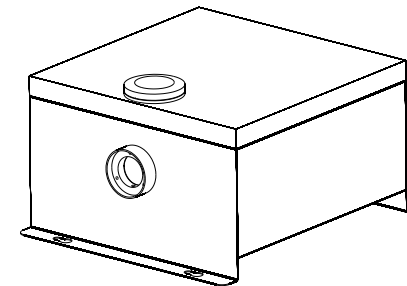

**ISO9001:2000
CERTIFIED**

LIGHT ENGINE USER MANUAL

Welcome to use LEI & LEJ series of professional light engine. Please read the manual carefully before turning on the light engine. If you have any questions concerning the operation or maintenance, please contact your wholesaler.

Safety Instruction

1. Make sure the Light Engine and Power Source have the same voltage;
2. Keep out of rain or moist area to avoid shock hazards;
3. Avoid to work in high ambient temperature ($>40^{\circ}\text{C}$);

CHAPTER 1 LEI-4001/WP & LEI-8001/WP & LEI-15001/WP

1. Technical Data

Voltage:	100V~240V AC
Power:	50W / 80W / 130W
LED:	White
Color Wheel:	6 colors
Light Source:	1-30W LED / 1-55W LED / 1-100W LED
Luminous Flux:	3500Lm / 6100Lm / 11000Lm (6000K)
Life of LED :	50000H
Size:	347X287X195mm ³
Gross Weight:	6.3Kg / 6.8Kg / 6.8Kg
Standard Aperture:	Ø28mm / Ø24mm / Ø20mm (Optional: Ø30mm Max)

2. Installation dimension of light engine (see Fig.1):

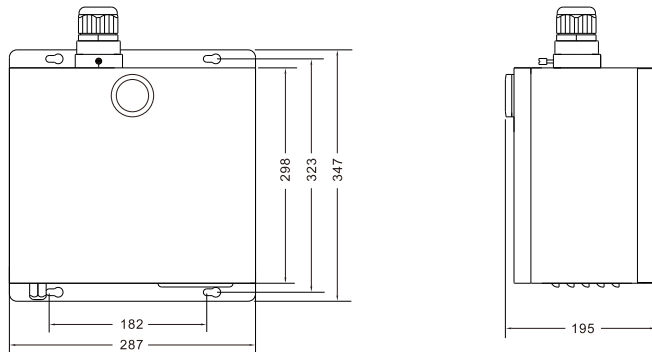

Fig. 1

3. Light Engine Setup:

- (1) DIP switches: SW1~SW3 for programs selection, please see Attached Table (1=ON, 0=OFF). SW4 and SW5 are blank; SW6 for remote control (see fig. 2)

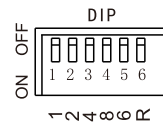

Fig. 2

- (2) Calculation of DIP address code:
e. g. $003=2(2)+1(1)$, $005=4(3)+1(1)$

(3) Wireless Remote Controller:

Set SW6 as "ON", and the remote controller starts to work. Button "🔒" is applied to fix color, button "🔌" for power on/off, and button "☀️" "🌟" used for brightness adjusting. (6 levels) (See Fig. 3)

- (4) Fixing Color With Wireless Remote Controller : Firstly set SW2 and SW3 as " ON " to choose the inbuilt programme, P06, of which the colors change at a slow speed, then press the button "🔒" on the controller to fix the color when the light engine displays the color that you need.

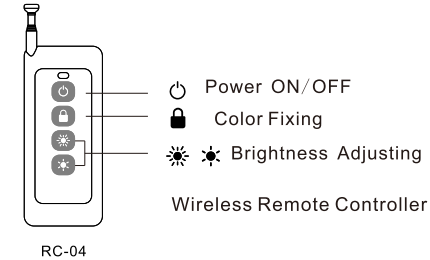

Fig. 3

Notice:

1. You could only control the motor to be on and off through "🔒" button.
If you want to have different color-change speed, please use DIP switch.
2. The dimmer on the rear panel is used for brightness manual adjustment.
The factory default is 100% brightness, and there are 6 levels of brightness in total.

Attached Table:

PRO. NO.	DIP SWITCH(1=ON, 0=OFF)						FUNCTION
	1	2	3	4	5	6	
0 0	0	0	0	0	0	0	Motor stopped, LED working
0 1	1	0	0	0	0	1	W, Sky-B,G,Y, B, PP, fade (6RPM)
0 2	0	1	0	0	0	1	W, Sky-B,G,Y, B, PP, fade (4RPM)
0 3	1	1	0	0	0	1	W, Sky-B,G,Y, B, PP, fade (3RPM)
0 4	0	0	1	0	0	1	W, Sky-B,G,Y, B, PP, fade (2RPM)
0 5	1	0	1	0	0	1	W, Sky-B,G,Y, B, PP, fade (1.5RPM)
0 6	0	1	1	0	0	1	W, Sky-B,G,Y, B, PP, fade (1RPM)
0 7	1	1	1	0	0	1	W, Sky-B,G,Y, B, PP, fade (0.5RPM)

- Notice:**
1. RPM is the speed of the color wheel;
 2. If DIP address is set beyond P07, the machine will run P07 instead.

CHAPTER 2

LEI-4001DMX/WP & LEI-8001DMX/WP & LEI-15001DMX/WP

1. Technical Data

Voltage:	100V~240V AC
Power:	50W / 80W / 130W
LED:	White
Color Wheel:	6 colors
Light Source:	1-30W LED / 1-55W LED / 1-100W LED
Luminous Flux:	3500Lm / 6100Lm / 11000Lm (6000K)
Life of LED :	50000H
Size:	347X287X195mm ³
Gross Weight:	6.5Kg / 6.5Kg / 7.0Kg
Standard Aperture:	Ø28mm / Ø24mm / Ø20mm (Optional: Ø30mm Max)

2. Installation dimension of light engine(see Fig1):

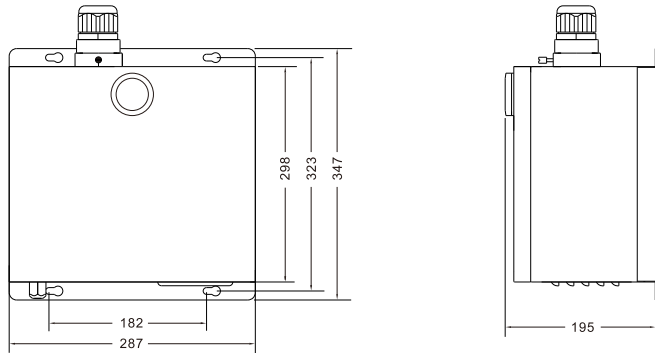

Fig. 1

3. Light Engine Setup

There are three control modes for LEI-Series DMX512 protocol Light Engine:

- * DMX512 Signal Control Mode: DMX512 console is applied to deliver the DMX signal.
- * Master/Slave Mode: One Light Engine is set as Master, while the rest light engines are set as Slave. Master delivers control signal to slave so that all the machines run the program synchronously.
- * Audio Control Mode: Light engines are controlled by sound.

(1) DMX 512 signal control mode:

a. Address Code Setup:

Press button "UP" and "DOWN" at the same time (maybe several times) until the digital display shows "001-508", then press the button "UP" or "DOWN" to select the address code.

b. DMX Channels: 5 Channels

CH1:Color CH2:Speed CH3:Blank CH4:Dimmer (256 level) CH5:Strobe

Notice: CH2 controls the switching speed of colors in CH1.
CH3 is the spare channel.

(2) Master/Slave mode: Master/Slave Machines Setup

STATUS	No.	MENU	DESCRIPTION OF FUNCTIONS	REMARKS
MASTER	1	P.00 - P.11	12 preset programs(see attached list. When it displays "P.XX", press "UP/DOWN" to get into this menu)	1. Hold and press the two buttons at the same time for 3 seconds to unlock the menu for setting up.
	2	P.5.1 - P.5.2	PS. 1-PS.2 are audio control programs (when it display "PS.X", press "UP/DOWN" to get into this menu)	2. Hold and press the button "UP", at the same time to press the button "DOWN" to switch the menu. Then release both buttons.
	3	5.00 - 5.07	Color wheel speed setup: total 8 levels:1/2RPM, 1RPM,2RPM,3RPM,4RPM,5RPM,8RPM,12RPM	3. Press either button of "UP" or "DOWN" to choose the right parameter.
	4	d.00 - d.99	Adjusting of brightness: total 8 levels: d.00,d.10,d.20, d.35,d.50,d.70,d.85,d.99.(d.99.means100% brightness)	4. After 60 seconds, the data will be saved and the menu locked.
	5	r.o.n - r.o.F	r.o.n: Remote control is on, r.o.F: Remote control is off.	5. When the display is on, the dot next to the third digit will flash if there is any DMX signal coming in.
Slave DMXReceiver	6	001 - 508	DMX address,"001"- "508"are available	

Notice:

- ① If you need Master/Slaves to change color synchronously, please set all of slaves as "001";
- ② If you need Master/Slaves to change color in sequence, please set first slave machine as "006", the second one as "011" and so on (add "5" one after another).

(3) The connection of DMX Signal Control Mode (See Fig. 2):

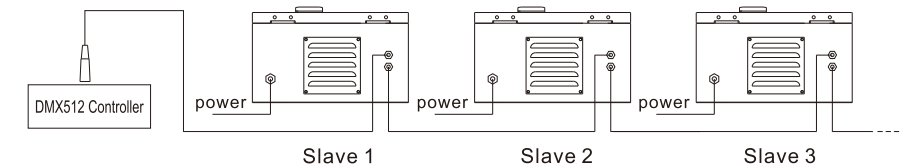

Fig. 2

(4) The connection of Master/Slave Control Mode (See Fig. 3):

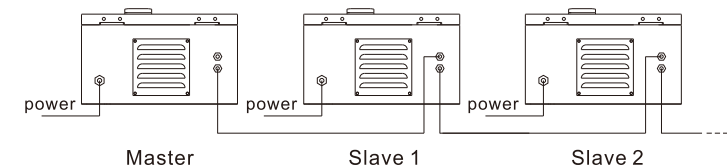

Fig. 3

(5) Signal cable and connector (See Fig.4):

Signal cable should be 2X0.5mm² audio cable.

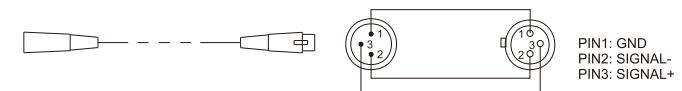

Fig4

4. Wireless remote controller (See Fig.5):

Press the two buttons "UP" / "DOWN" besides the Display at the same time. When it displays "r. on" or "r. of", press either button of "UP" / "DOWN" to show "r. on" (status of remote control). The remote function is on.

15-Key Remote Controller:

- (1) Program Selection: Press "PRO", then press the digit key on the controller, "00"- "13", to choose the desirable program, or you can use "▲", "▼" to select.
- (2) Dimming: Press the key "DIM", then press "0"- "7" to have the desirable brightness, or you can use "▲", "▼" to adjust.
- (3) Speed of the twinkle wheel: Press the key "SP", then press "0"- "7" to adjust the speed, or you can use "▲", "▼" to adjust.



RC-15
Wireless Remote Controller
Fig.5

Notice:

- ① Address code of slave (machines) are not adjustable under remote control status.
- ② When you are selecting the program, only double-digit numbers on the controller are recognizable (e.g. 00, 01, 02...).

Attached Table: Program and the Program number

Pro. No.	Function	Pro. No.	Function	Pro. No.	Function
P.00	No Light	P.06	Red	PS.1	6 colors skip & audio control
P.01	White	P.07	6 colors skip	PS.2	5 colors skip & audio control
P.02	Sky-B	P.08	5 colors skip		
P.03	Green	P.09	6 colors fade		
P.04	Yellow	P.10	6 colors skip & chase		
P.05	Blue	P.11	6 colors fade & chase		

CHAPTER 3 LEJ-4001DMX/WP & LEJ-8001DMX/WP

1. Technical Data

Voltage:	100V~240V AC
Power:	55W / 85W
LED:	White
Color Wheel:	6 colors
Light Source:	1-30W LED / 1-55W LED
Luminous Flux:	3500Lm / 6100Lm (6000K)
Life of LED :	50000H
Size:	347X287X195mm ³
Gross Weight:	6.5Kg / 6.8Kg / 7.0Kg
Standard Aperture:	Ø28mm / Ø24mm / Ø20mm (Optional: Ø30mm Max)

2. Installation dimension of light engine (see Fig.1):

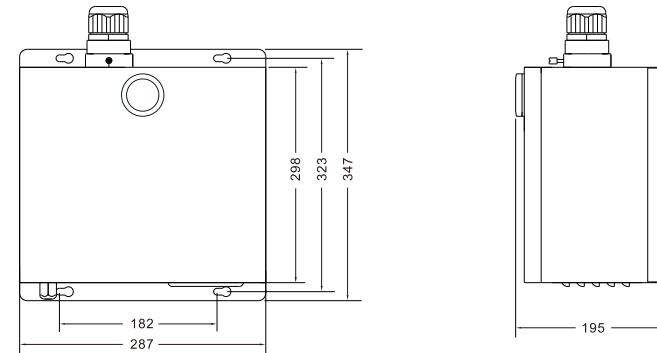

Fig. 1

3. Light Engine Setup

There are three control modes for LEI-Series DMX512 protocol Light Engine:

- * DMX512 Signal Control Mode: DMX512 Signal is received from a DMX512 controller.
- * Master/Slave Mode: One Light Engine is set as Master, while the rest light engines are set as Slave. Master sends control signal to slave so that all the machines run the program synchronously.
- * Audio Control Mode: Light engines are controlled by sound.

(1) DMX 512 signal control mode:

Address Code Setup:

Press button "UP" and "DOWN" at the same time (maybe several times) until the digital display shows "001-508", then press the button "Up" or "DOWN" to select the address code.

DMX Channels: 5 Channels / 3 Channels / 2 Channels / 1 Channels

5 Channels: CH1:Color CH2:Speed CH3:Twinkle CH4:Dimmer (256 levels)
CH5:Strobe

3 Channels: CH1:Dimmer (256 levels) CH2:Color CH3:Twinkle

2 Channels: CH1:Dimmer (256 levels) CH2:Color

1 Channels: CH1:Dimmer (256 levels)

Notice: 2 Channels & 1 Channels Twinkle wheel-call the preset programs.
(can be controlled by remote controller)

(2) Master/Slave mode: The setting of Master/Slave

STATUS	No.	MENU	DESCRIPTION OF FUNCTIONS	REMARKS
MASTER	1	P.00-P.21	12 preset programs(see attached list,when it display "P.XX",press "UP/DOWN" to get into this menu)	1. Hold and press the two buttons at the same time for 3 seconds to unlock the menu for setting up. 2. Hold and press the button "UP", at the same time to press the button "DOWN" to switch the menu. Then release both buttons. 3. Press either button of "UP" or "DOWN" to choose the right parameter. 4. After 60 seconds, the data will be saved and the menu locked. 5. When the display is on, the dot next to the third digit will flash if there is any DMX signal coming in.
	2	PS.1-PS.2	PS.1-PS.2 are audio control programs (when it display "PS.X",press "UP/DOWN" to get into this menu)	
	3	5.00-5.07	Setting of program running speed, total 8 levels: 0S,1/4S,1/2S,1S,2S,3S,5S,8S	
	4	55.0-55.7	Setting of twinkle wheel speed, total 8 levels: 0RPM,1RPM,2RPM,3RPM,4RPM,5RPM,8RPM,12RPM	
	5	d.00-d.99	Adjusting of brightness, total 8 levels :d.00,d.10,d.20, d.35,d.50,d.70,d.85,d.99.(d.99.means100% brightness)	
	6	r.on-r.oF	r.on: Remote control is on, r.oF: Remote control is off.	
	7	[h1]/[h2]/[h5]	Slaves to CH5	
Slave DMXReceiver	8	001-505	DMX address,"001"-508"are available	

Notice:

- ① If you need Master/Slaves to change color synchronously, please set all of slaves into "001";
- ② If you need Master/Slaves to chase to change color, please set slaves into "006", "011" and so on (add "5" one after another).

(3) The connection of DMX Signal Control Mode (See Fig. 2):

Fig. 2

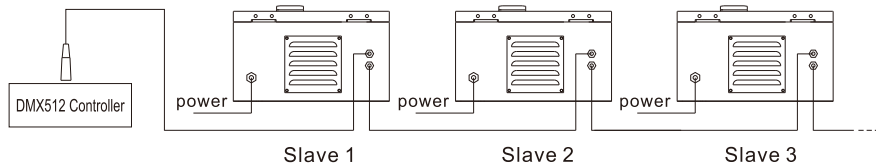

(4) The connection of Master/Slave Control Mode (See Fig. 3):

Fig. 3

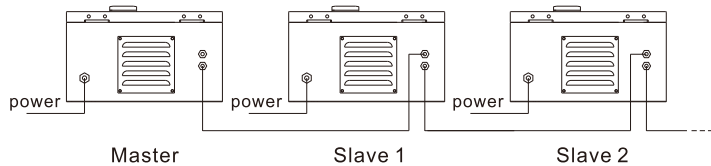

(5) Signal cable and connector (See Fig.4):

Signal cable should be 2X0.5mm² audio cable.



4. Wireless remote controller (See Fig.5):

Press the two buttons "UP" / "DOWN" besides the Display at the same time. When it displays "r. on" or "r. oF", press either button of "UP" / "DOWN" to show "r. on" (status of remote control). The remote function is on.

15-Key Remote Controller:

- (1) Program Selection: Press "PRO", then press the digit key on the controller, "00"-23", to choose the desirable program, or you can use "▲", "▼" to select.
- (2) Dimming: Press the key "DIM", then press "0"-7" to have the desirable brightness, or you can use "▲", "▼" to adjust.
- (3) Color-changing speed: Press the key "SP", then press "0"-7" to adjust the speed, or you can use "▲", "▼" to adjust.
- (4) Speed of the twinkle wheel: Press the key "9", then press "0"-7" to adjust the speed of the twinkle wheel, or you can use "▲", "▼" to adjust.

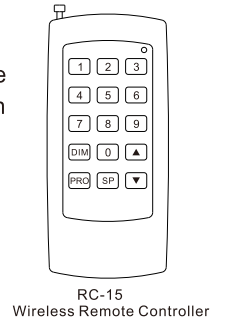

Fig.5

Notice:

- ① Address code of slave (machines) are not adjustable under remote control status.
- ② When you are selecting the program, only double-digit numbers on the controller are recognizable (e.g. 00, 01, 02...).

Attached List :

Pro. No.	Function	Pro. No.	Function	Pro. No.	Function
P.00	No Light	P.06	Red	PS.1	6 colors skip & audio control
P.01	White	P.07	6 colors skip	PS.2	5 colors skip & audio control
P.02	Sky-B	P.08	5 colors skip		
P.03	Green	P.09	6 colors fade		
P.04	Yellow	P.10	6 colors skip & chase		
P.05	Blue	P.11	6 colors fade & chase		

Chapter 4 Installation of Fiber Optic

1. Connecting the fiber optic with Light Engine:

Solid Core fiber optic(See Fig. 1):

- (1) Cut the fiber to the specified length. The cross section should be vertical to the fiber and keep clean and smooth.
- (2) Peel off 50-100mm of the PVC jacket of the fiber optic cable (not necessary if there is no PVC jacket). Be careful not to hurt the fiber optic.
- (3) Unscrew the PG Connector and insert the fiber optic cable into the PG Connector and Fiber Connector until the end of the cable is flush with the Fiber Connector. Screw tightly the PG Connector.
- (4) Insert the finished Fiber Connector into the Fixing Flange, screw tightly the Screw.

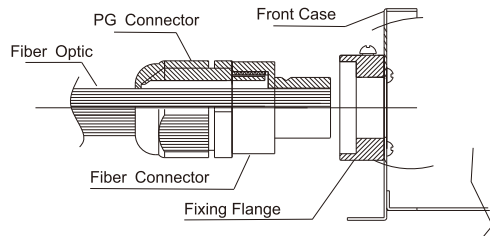

Fig. 1

2. Installation of the end part of the Multi-String fiber optic:

- (1) Drill holes on the installing board according to the design. Then insert the fiber optic string into holes and fix it with epoxy glue. Trim the end of the fiber string to be flush with the board or at a required length. Fasten the other end of the fiber string to a harness and insert the harness into PG Connector and Fiber Connector. Apply the hot knife to cut fiber end flush with the Fiber Connector. (See Fig.2).
- (2) Insert the finished Fiber Connector into the Fixing Flange and screw tightly the Screw.

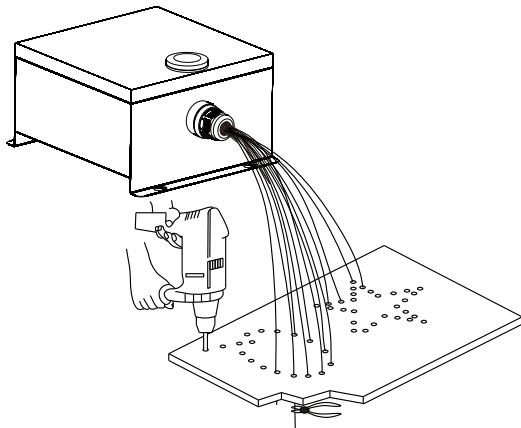

Fig. 2

3. Commonly used installation method of fiber optic cable:

- (1) Side Lighting Fiber Optic:(See Fig.3).

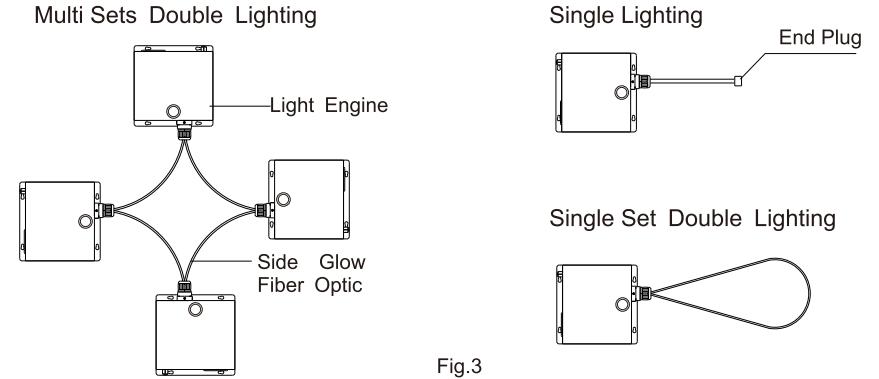

Fig.3

- (2) End Lighting Fiber Optic. (See Fig.4).

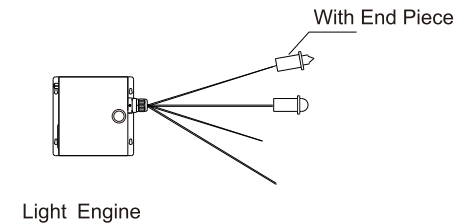

Fig.4